

COASTAL RANGE DÒNG PHỤ KIỆN INOX 316

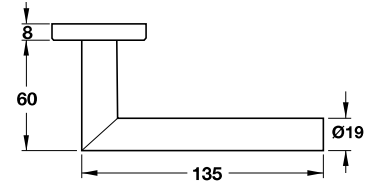
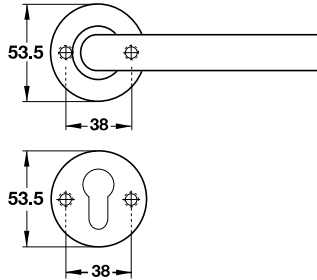

SUS 316

Description Mô tả	Function Chức năng	Door thickness Độ dày cửa	Materials Vật liệu	Finish Hoàn thiện	Art. No. Mã số	Price (VND) Giá (Đ)
Lever handle on rosette Tay nắm gạt có nắp che	PC Set / Cửa phòng 	38-55 mm	SUS316 Inox 316	 Satin Stainless Steel Inox mờ	903.98.536	

Supplied with: 2 lever handle parts, 1 pair of handle roses, 1 pair of PC escutcheons, 1 set screw fixing.

Tron bộ gồm: 2 tay nắm gạt, 1 bộ nắp chụp tay nắm, 1 bộ nắp chụp ruột khóa PC, 1 bộ vít.

Packing: 1 set / **Đóng gói:** 1 bộ

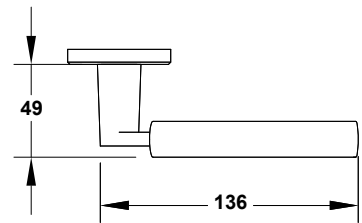
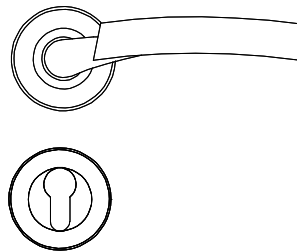

SUS 316

Description Mô tả	Function Chức năng	Door thickness Độ dày cửa	Materials Vật liệu	Finish Hoàn thiện	Art. No. Mã số	Price (VND) Giá (Đ)
Lever handle on rosette Tay nắm gạt có nắp che	PC Set / Cửa phòng 	38-50 mm	SUS316 Inox 316	 Satin Stainless Steel Inox mờ	903.99.723	

Supplied with: 2 lever handle parts, 1 pair of handle roses, 1 pair of PC escutcheons, 1 set screw fixing.

Tron bộ gồm: 2 tay nắm gạt, 1 bộ nắp chụp tay nắm, 1 bộ nắp chụp ruột khóa PC, 1 bộ vít.

Packing: 1 set / **Đóng gói:** 1 bộ

COASTAL RANGE DÒNG PHỤ KIỆN INOX 316

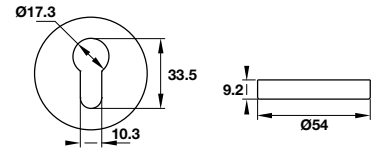
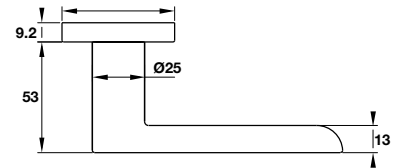
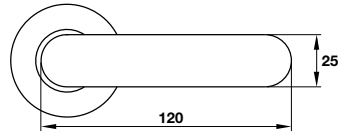

COASTAL RANGE

SUS 316

Description Mô tả	Function Chức năng	Door thickness Độ dày cửa	Materials Vật liệu	Finish Hoàn thiện	Art. No. Mã số	Price (VND) Giá (Đ)
Lever handle on rosette Tay nắm gạt có nắp che	PC Set / Cửa phòng 	38-50 mm	SUS316 Inox 316	Satin Stainless Steel Inox mờ	903.98.162	

Supplied with: 2 lever handle parts, 1 pair of handle roses, 1 pair of PC escutcheons, 1 set screw fixing.

Tron bộ gồm: 2 tay nắm gạt, 1 bộ nắp chụp tay nắm, 1 bộ nắp chụp ruột khóa PC, 1 bộ vít.

Packing: 1 set / Đóng gói: 1 bộ

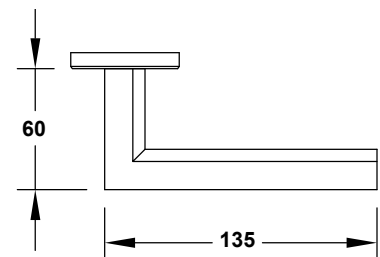
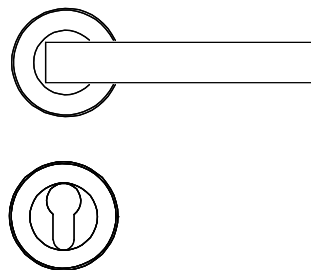

SUS 316

Description Mô tả	Function Chức năng	Door thickness Độ dày cửa	Materials Vật liệu	Finish Hoàn thiện	Art. No. Mã số	Price (VND) Giá (Đ)
Lever handle on rosette Tay nắm gạt có nắp che	PC Set / Cửa phòng 	38-50 mm	SUS316 Inox 316	Satin Stainless Steel Inox mờ	903.99.724	

Supplied with: 2 lever handle parts, 1 pair of handle roses, 1 pair of PC escutcheons, 1 set screw fixing.

Tron bộ gồm: 2 tay nắm gạt, 1 bộ nắp chụp tay nắm, 1 bộ nắp chụp ruột khóa PC, 1 bộ vít.

Packing: 1 set / Đóng gói: 1 bộ

COASTAL RANGE DÒNG PHỤ KIỆN INOX 316

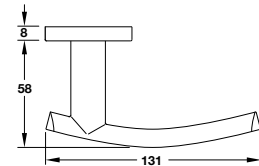
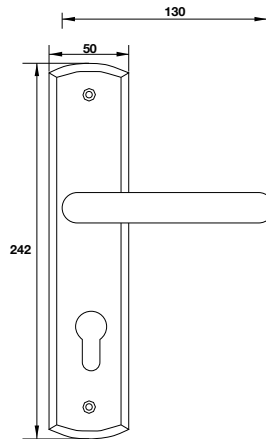

SUS 316

Description Mô tả	Door Direction Hướng mở cửa	C/C	Door thickness Độ dày cửa	Materials Vật liệu	Finish Hoàn thiện	Art. No. Mã số	Price (VND) Giá (Đ)
Lever handle on backplate set Tay nắm gạt để dài	DIN R Mở phải	72 mm	38-50 mm	SUS316 Inox 316	Satin Stainless Steel Inox mờ	903.78.588 /	

Supplied with: 2 lever handles on plate, 1 set screw fixing.

Trọn bộ gồm: 2 tay nắm gạt để dài, 1 bộ vít.

Packing: 1 set / Đóng gói: 1 bộ

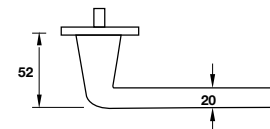
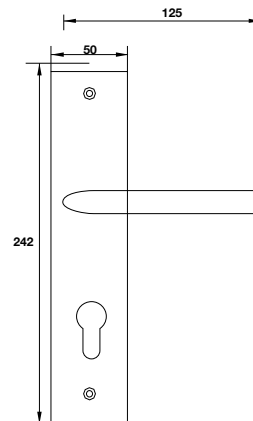

SUS 316

Description Mô tả	Door Direction Hướng mở cửa	C/C	Door thickness Độ dày cửa	Materials Vật liệu	Finish Hoàn thiện	Art. No. Mã số	Price (VND) Giá (Đ)
Lever handle on backplate set Tay nắm gạt để dài	DIN R Mở phải	72 mm	38-50 mm	SUS316 Inox 316	Satin Stainless Steel Inox mờ	903.78.589 /	

Supplied with: 2 lever handles on plate, 1 set screw fixing.

Trọn bộ gồm: 2 tay nắm gạt để dài, 1 bộ vít.

Packing: 1 set / Đóng gói: 1 bộ

COASTAL RANGE DÒNG PHỤ KIỆN INOX 316

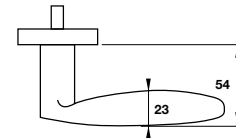
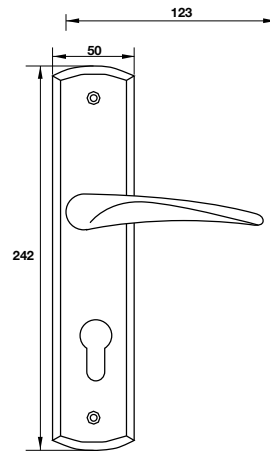

COASTAL RANGE

SUS 316

Description Mô tả	Door Direction Hướng mở cửa	C/C	Door thickness Độ dày cửa	Materials Vật liệu	Finish Hoàn thiện	Art. No. Mã số	Price (VND) Giá (Đ)
Lever handle on backplate set Tay nắm gạt để dài	DIN R Mở phải	72 mm	38-50 mm	SUS316 Inox 316	● Satin Stainless Steel Inox mờ	903.78.590	

Supplied with: 2 lever handles on plate, 1 set screw fixing.

Trọng bộ gồm: 2 tay nắm gạt để dài, 1 bộ vít.

Packing: 1 set / Đóng gói: 1 bộ

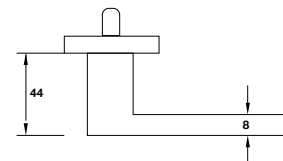
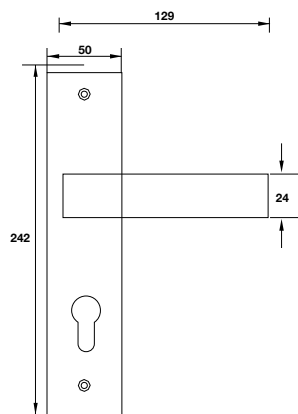

SUS 316

Description Mô tả	Door Direction Hướng mở cửa	C/C	Door thickness Độ dày cửa	Materials Vật liệu	Finish Hoàn thiện	Art. No. Mã số	Price (VND) Giá (Đ)
Lever handle on backplate set Tay nắm gạt để dài	DIN R Mở phải	72 mm	38-50 mm	SUS316 Inox 316	● Satin Stainless Steel Inox mờ	903.78.591	

Supplied with: 2 lever handles on plate, 1 set screw fixing.

Trọng bộ gồm: 2 tay nắm gạt để dài, 1 bộ vít.

Packing: 1 set / Đóng gói: 1 bộ

COASTAL RANGE DÒNG PHỤ KIỆN INOX 316

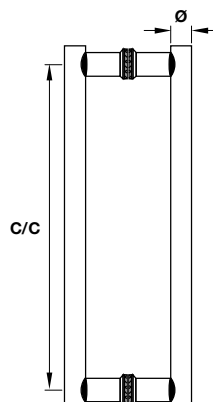
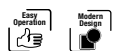
**SUS 316**

Description Mô tả	Dimension (mm) Kích thước (mm)	Door thickness (mm) Độ dày cửa (mm)	Materials Vật liệu	Finish Hoàn thiện	Art. No. Mã số	Price (VND) Giá (Đ)
H-styled Pull Handle Tay nắm kéo chữ H	Ø30 x C-C 400 x L600	For glass door: 8-12 For wooden door: 38-55	SUS316 Inox 316	● Satin Stainless Steel Inox mờ	903.01.843	
	Ø30 x C-C 1000 x L1200	Cho cửa kính: 8-12 Cho cửa gỗ: 38-55			903.01.846	

Supplied with: 1 pair of pull handle, 1 set screw fixing.

Trọn bộ gồm: 1 cặp tay nắm kéo, 1 bộ vít.

Packing: 1 set / Đóng gói: 1 bộ

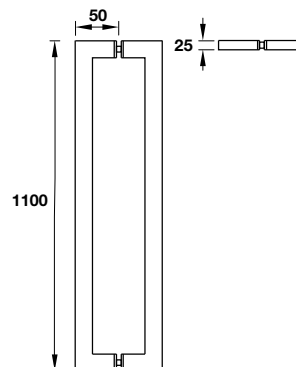
**SUS 316**

Description Mô tả	Dimension (mm) Kích thước (mm)	Door thickness (mm) Độ dày cửa (mm)	Materials Vật liệu	Finish Hoàn thiện	Art. No. Mã số	Price (VND) Giá (Đ)
Square Pull Handle Tay nắm kéo dạng vuông	C-C 1075 x L1100	For glass door: 8-12 For wooden door: 38-55 Cho cửa kính: 8-12 Cho cửa gỗ: 38-55	SUS316 Inox 316	● Satin Black Đen mờ	903.02.030	

Supplied with: 1 pair of pull handle, 1 set screw fixing.

Trọn bộ gồm: 1 cặp tay nắm kéo, 1 bộ vít.

Packing: 1 set / Đóng gói: 1 bộ

COASTAL RANGE DÒNG PHỤ KIỆN INOX 316

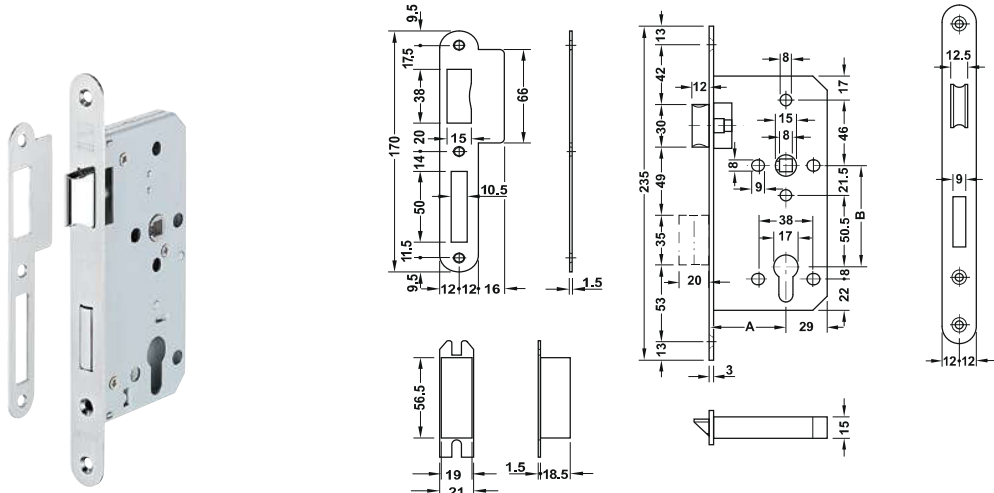

COASTAL RANGE

SUS 316

Description Mô tả	Backset	C/C	Materials Vật liệu	Finish Hoàn thiện	Art. No. Mã số	Price (VND) Giá (Đ)
Mortise lock for profile cylinder Thân khóa lưỡi gà chốt chết	55 mm	72 mm	SUS316 Inox 316	Satin Stainless Steel Inox mờ	911.25.402	

Supplied with: 1 mortise lock, 1 striking plate, 1 plastic box, 1 fixing screw.
Trọn bộ gồm: 1 thân khóa, 1 bas thân khóa, 1 bas hộp nhựa, vít.
Packing: 1 set / Đóng gói: 1 bộ

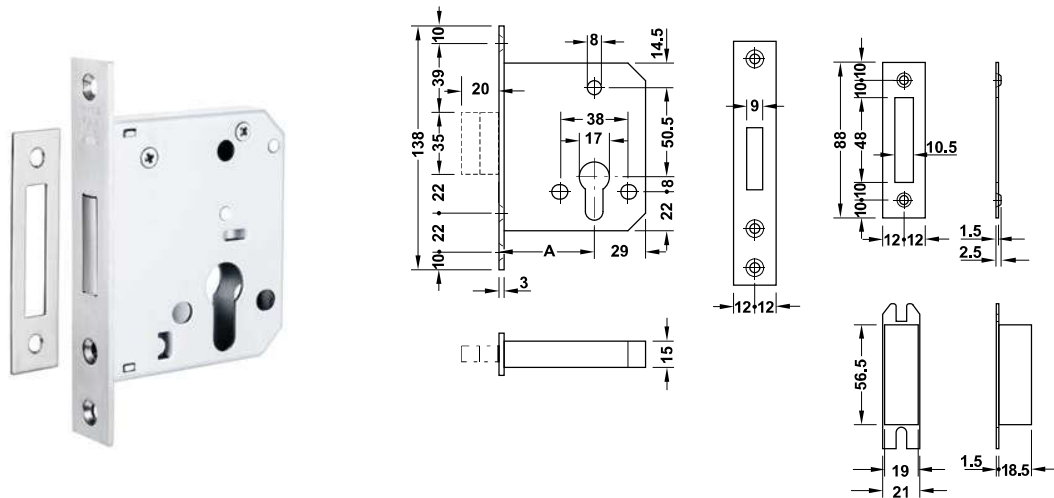

SUS 316

Description Mô tả	Backset	Materials Vật liệu	Finish Hoàn thiện	Art. No. Mã số	Price (VND) Giá (Đ)
Mortise deadbolt lock Thân khóa chốt chết	55 mm	SUS316 Inox 316	Satin Stainless Steel Inox mờ	911.22.386	

Supplied with: 1 mortise lock, 1 striking plate, 1 plastic box, 1 fixing screw.
Trọn bộ gồm: 1 thân khóa, 1 bas thân khóa, 1 bas hộp nhựa, vít.
Packing: 1 set / Đóng gói: 1 bộ

*Backset: Khoảng cách từ cạnh cửa đến tâm lỗ ruột khóa.

COASTAL RANGE DÒNG PHỤ KIỆN INOX 316

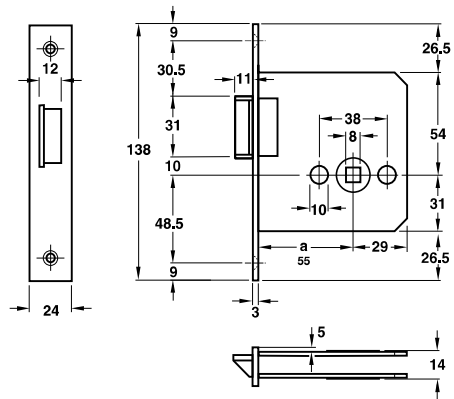

SUS 316

Description	Materials	Finish	Art. No.	Price (VND)
Mô tả	Vật liệu	Hoàn thiện	Mã số	Giá (Đ)
Mortise latch lock Thân khoá lưỡi gà	SUS316 Inox 316	Satin Stainless Steel Inox mờ	911.23.438	

Supplied with: 1 mortise lock, 1 striking plate, 1 plastic box, 1 fixing screw.

Trọn bộ gồm: 1 thân khoá, 1 bas thân khoá, 1 bas hộp nhựa, vít.

Packing: 1 set / Đóng gói: 1 bộ

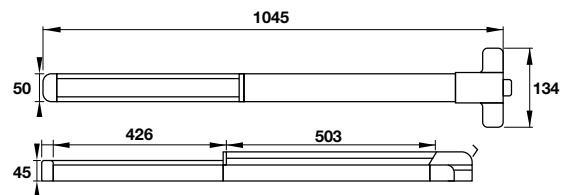

SUS 316

Description	Materials	Finish	Art. No.	Price (VND)
Mô tả	Vật liệu	Hoàn thiện	Mã số	Giá (Đ)
Touch bar Thanh thoát hiểm	SUS316 Inox 316	Satin Stainless Steel Inox mờ	911.52.151	

Supplied with: 1 touch bar, 1 striking plate

Trọn bộ gồm: 1 Thanh thoát hiểm, 1 Bas chốt

Packing: 1 set / Đóng gói: 1 bộ

*Backset: Khoảng cách từ cạnh cửa đến tâm lỗ ruột khoá.

COASTAL RANGE DÒNG PHỤ KIỆN INOX 316

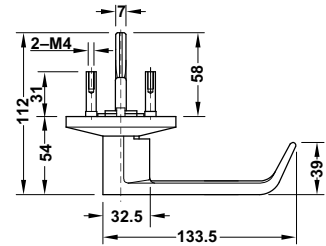
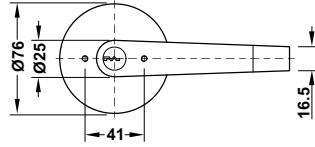

COASTAL
RANGE

SUS 316

Description Mô tả	Materials Vật liệu	Finish Hoàn thiện	Art. No. Mã số	Price (VND) Giá (Đ)
Lever handle on rosette Tay nắm gạt có nắp che	SUS316 Inox 316	● Satin Stainless Steel Inox mờ	911.54.037	

Packing: 1 set / Đóng gói: 1 bộ



COASTAL RANGE DÒNG PHỤ KIỆN INOX 316

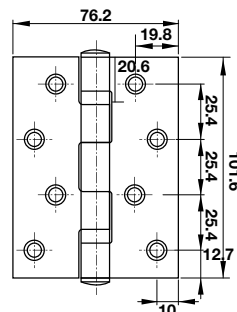
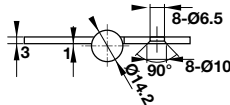
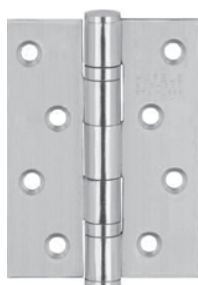

SUS 316

Description Mô tả	Max. door weight with 3 hinges Chịu lực với 3 bản lề	Materials Vật liệu	Finish Hoàn thiện	Art. No. Mã số	Price (VND) Giá (Đ)
Butt hinge 102x76x3mm-2BB with machine screws Bản lề lá 102x76x3mm-2 vòng bi kèm vít cho cửa thép	70kg	SUS316 Inox 316	● Satin Stainless Steel Inox mờ	926.20.111	

Price based on 1 piece. / Giá được tính trên 1 cái.

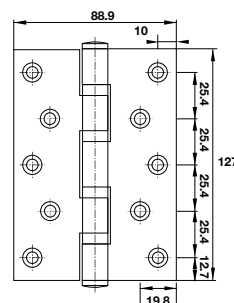
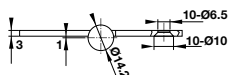

SUS 316

Description Mô tả	Max. door weight with 3 hinges Chịu lực với 3 bản lề	Materials Vật liệu	Finish Hoàn thiện	Art. No. Mã số	Price (VND) Giá (Đ)
Butt hinge 127x89x3mm-2BB with machine screws Bản lề lá 127x89x3mm-2 vòng bi kèm vít cho cửa thép	80kg	SUS316 Inox 316	● Satin Stainless Steel Inox mờ	926.20.121	

Price based on 1 piece. / Giá được tính trên 1 cái.

COASTAL RANGE DÒNG PHỤ KIỆN INOX 316

NEW

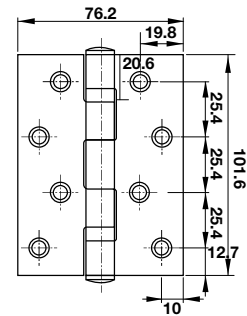
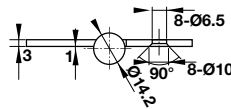

COASTAL RANGE

SUS 316

Description Mô tả	Max. door weight with 3 hinges Chịu lực với 3 bản lề	Materials Vật liệu	Finish Hoàn thiện	Art. No. Mã số	Price (VND) Giá (Đ)
Butt hinge 102x76x3mm-2BB Bản lề lá 102x76x3mm-2 vòng bi	70kg	SUS316 Inox 316	● Satin Stainless Steel Inox mờ	926.20.112	

Price based on 1 piece. / Giá được tính trên 1 cái.

NEW

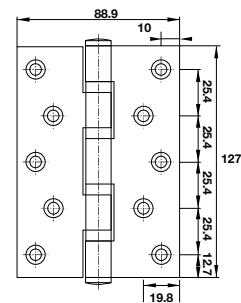
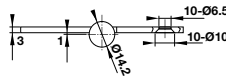

SUS 316

Description Mô tả	Max. door weight with 3 hinges Chịu lực với 3 bản lề	Materials Vật liệu	Finish Hoàn thiện	Art. No. Mã số	Price (VND) Giá (Đ)
Butt hinge 127x89x3mm-2BB Bản lề lá 127x89x3mm-2 vòng bi	80kg	SUS316 Inox 316	● Satin Stainless Steel Inox mờ	926.20.122	

Price based on 1 piece. / Giá được tính trên 1 cái.